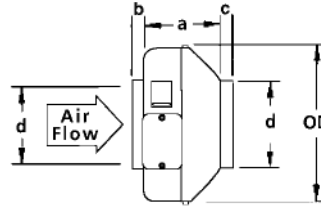

MANUFACTURERS INDEX, SECTION 10

AIRMASTER.....	10-6 – 10-11
BROAN.....	10-2 – 10-5
MASTERFLOW.....	10-1
TJERNLUND.....	10-1

HIGH PERFORMANCE DUCT BOOSTER® FANS

Versatile and durable Tjernlund High Performance Fans feature exceptional air handling performance with low noise and extremely low power usage.

- Use in temperatures up to 140°F
- Variable speed adjustable
- Permanently sealed bearings
- Totally enclosed
- Maintenance free
- Quiet operation



M-Series (Metal Housing)

Ideal for long runs or air supply and exhaust applications requiring a metal housing.

Features include:

- Powder coated, galvanized housing
- Horizontal or vertical mounting
- Connects to rigid or flex ducts
- Mounting bracket included

Dimensions

Model	OD	a	b	c	d
M-4	8	5-1/2	7/8	7/8	4
M-6	11-1/2	6	3/4	7/8	6
M-8	13-1/4	6-1/4	1	7/8	8

M-Series Electrical and Performance Data

Model	Max Amps	Max Watts	Volts	Nom. RPM	CFM VS Static Pressure								Duct Dia.	Weight
					0"	1/8"	1/4"	3/8"	1/2"	3/4"	1"	1 1/2"		
M-4	.17	19	115	2950	117	101	86	72	58	--	--	--	4"	6 Lbs
M-6	.74	84	115	2700	257	241	221	197	178	143	99	--	6"	9 Lbs
M-8	1.02	116	115	2600	481	444	403	361	319	237	177	76	8"	11 Lbs

VENTILATION ACCESSORIES



VERSA-CAP®

NON-CLOGGING POSITIVE DRAFT DESIGN
RECOMMENDED FOR CHIMNEY OR HOT STACK
APPLICATIONS.

PART #	ADJUSTABLE THROAT SIZE
3050	2-7/8" - 5"
5070	4-7/8" - 7"
7090	6-7/8" - 9"
9011	8-7/8" - 11"
1200	12" - 14"



POWER ATTIC VENTILATORS

ROOF OR GABLE MOUNTED DESIGNS.

PART #	MOUNTING	CFM @ .03 S.P.
PR2	ROOF	1300
PG2N	GABLE	1300
HI22BZ*	ROOF	1300



*Weathered Wood look.

FLUSH FLANGE WALL LOUVERS

REVERSIBLE FOR FLUSH OR RECESSED MOUNTING ON
FRAME OR BRICK STRUCTURES.



PART #	OPENING DIMENSIONS	FREE AREA SQR. IN.
DA1824	18 x 24	180
DA2430	24 x 30	302

ROOF LOUVERS

50 SERIES - 77 SERIES

SQUARE HOOD DESIGN FOR EFFECTIVE WEATHER PROTECTION AND MAXIMUM AIR MOVEMENT. CAN BE USED ON ANY ROOF NOT EXCEEDING 6/12 PITCH.



PART #	FLASHING DIMENSIONS
R50A	17-3/8" x 15-3/8"
R77A	17" x 17-3/8"

VERTICAL DISCHARGE FANS

Efficient, high-performance for ceiling installations. Offered in two sizes to meet Various room requirements.

MODEL	VOLTS	CFM	DUCT
504	120	350	10" Rd.
505	120	180	8" Rd.



MODEL 504 HOUSING

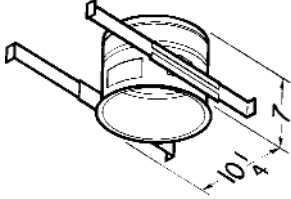

MODEL 505 HOUSING

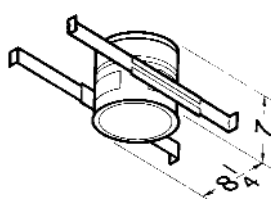

MODEL 504 GRILLE

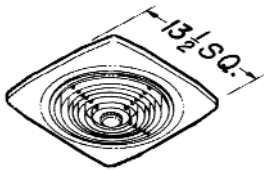

MODEL 505 GRILLE

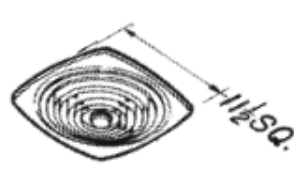

MODEL 673

VOLTS	RPM	SONES	CFM	DUCT
120	2600	4.5	60	6" Round

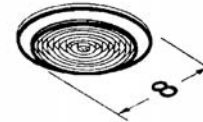
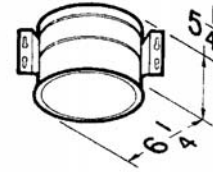

WALL FAN



MODEL	VOLTS	CFM	DUCT
508	120	270	10" Rd.

MODEL 508 HOUSING

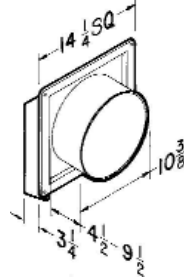

MODEL 508 GRILLE

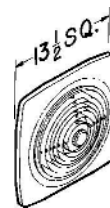

ROOF CAPS

Model 612

- For flat roof installation
- .025 Aluminum - natural finish
- Built-in bird screen
- For up to 12" round duct

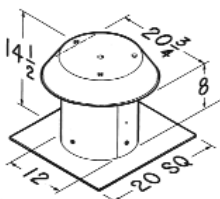

MODEL 634

- 24 GA. CRCQ steel, black electrically-bonded epoxy finish
- Built-in backdraft damper and bird screen
- For 3-1/4" x 10" or up to 8" round duct

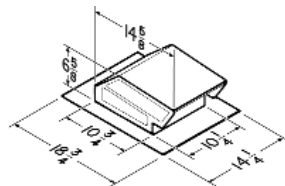

MODEL 636

- 24 GA. CRCQ steel, black electrically-bonded epoxy finish
- Built-in backdraft damper and bird screen
- For 3" or 4" round duct

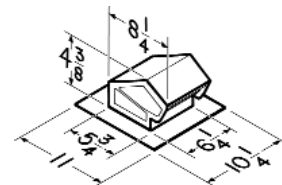

Wall Control

MODEL 57V (IVORY), 57X (WHITE) Electronic Variable Speed Control (3 Amp)

- Rotary dial for variable selection of fan speed and sound level
- Positive off position
- Fits single-gang box
- Built-in radio noise suppressor
- 120 VAC, 3.0 Amp capacity
- For use with all Broan fans within Amp rating except ceiling paddle fans
- Do not use with impedance protected motor

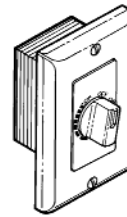

COMBINATION UNITS



Model 655 — Heater/Fan/Light

Model 657 — Fan/Light

GRILLE:

- White polymeric grille
- Directional vanes for heat and exhaust
- Snap-in light diffusing lens for 100W bulb (not included)

VENTILATOR

- Low sound, high performance blower wheel

HEATER

- 1300 watts, with metal blower wheel for efficient, even heating

MODEL	DESCRIPTION	VOLTS	AMPS	CFM	DUCT
655	Heater/Fan/Light	120	12.8	70	4" Round
657	Fan/Light	120	2.0	70	4" Round

MODELS 655 & 657

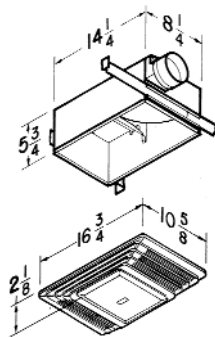

MODEL 696

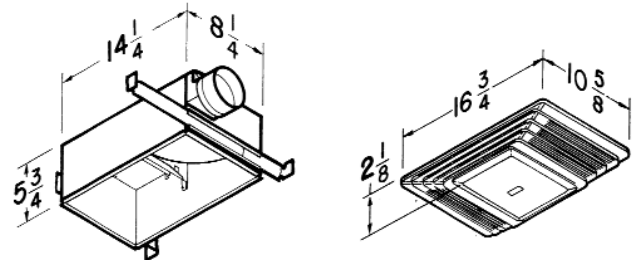

MODEL 696 — Fan/Light

- Two blower wheels, each powered by its own permanently lubricated-plug-in motor, quietly deliver high-efficiency performance.

MODEL NO.	SONES @ 0.0" S.P.	CFM @ STATIC PRESSURE .250	VOLTS	SIZE
696	5.1	100	120	4" Round

WALL CAPS

MODEL 639

- For 3 1/4" x 10" duct
- Spring-loaded backdraft damper and bird screen
- 24 GA CRCQ Steel, black electrical ly-bonded epoxy finish.

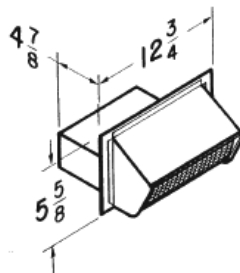

MODEL 642

- For 3" or 4" round duct
- Built-in backdraft damper

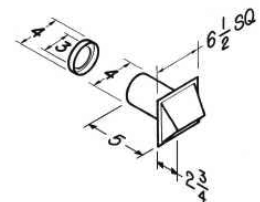

MODEL 641 / 843BL

- For 6" round duct
- Spring-loaded backdraft damper and bird screen
- 22 GA CRCQ Steel, black electrically bonded epoxy

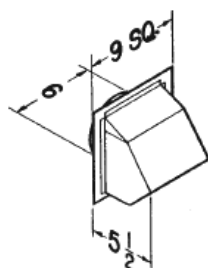

MODEL 643

- For 8" round duct
- Built-in backdraft damper
- .025 Aluminum - natural finish

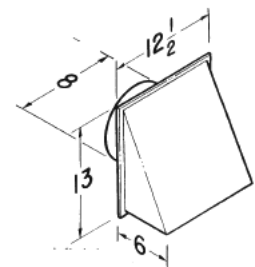

CEILING/WALL FANS



- Durable Broan-designed blower wheel.
- Torsion spring grille mounting – no tools necessary.
- Compact housing fits easily between ceiling joists or wall studs.
- Double strength steel mounting flanges with keyhole slots for fast installation.

MODEL 670

MODEL NO.	SONES @ 0.0" S.P.	CFM @ STATIC PRESSURE .250	TOTAL VOLTS	SIZE
670	3.4	46	120	3" Round

MODEL 671

MODEL	VOLTS	CFM	SONES	DUCT
671	120	70	6.0	3" Round

MODEL 676

MODEL	VOLTS	SONES	CFM	DUCT
676	120	4.0	110	4" Round

MODEL 678

MODEL	VOLTS	SONES	CFM	DUCT
678	120	2.5	50	4" Round

MODEL 679

MODEL	VOLTS	SONES	CFM	DUCT
679	120	3.5	70	4" Round

MODEL 684

MODEL NO.		STATIC PRESSURE (in. wg Ps) .250	VOLTS	DUCT SIZE
684	CFM	77	120	4" Round
	Sones	3.6		

MODELS 688 & 689

MODEL	VOLTS	SONES	CFM	DUCT
688	120	4.0	50	3" Round
689	120	5.5	60	3" Round

SOLITAIRE® BATH FANS

Ultra-quiet high performance fans with a modern styled, low profile grille.

MODEL NO.	SONES @ 0.1" S.P.	CFM @ STATIC PRESSURE .250	VOLTS	SIZE
S90	2.5	90	120	4" Round

MODELS 670 & 671

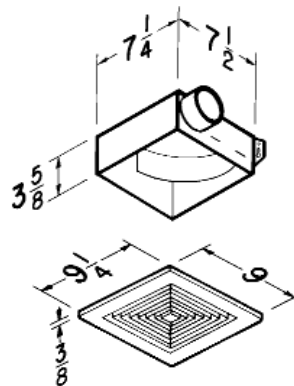

MODELS 676 & 684

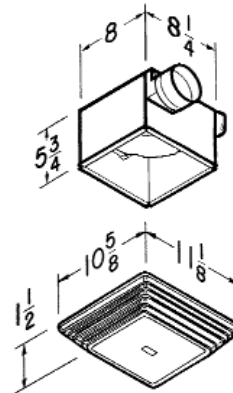

MODELS 688 & 689

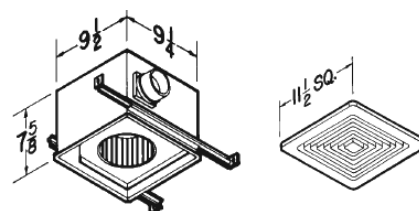
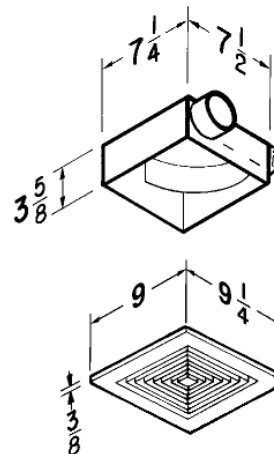

SOLITAIRE ULTRA-SILENT® VENTILATION FANS

Ultra-quiet high performance fans with a modern styled, low profile grille.

ACCESSORIES

- Plug in permanently lubricated motor
- Low RPM for ultra-quiet performance

MODEL NO.	SONES @ 0.1" S.P.	CFM @ STATIC PRESSURE .250	VOLTS	SIZE
S50U	.05	50	120	4" Round
QTR80	1.0	80	120	4" Round
S110U	1.5	110	120	4" Round

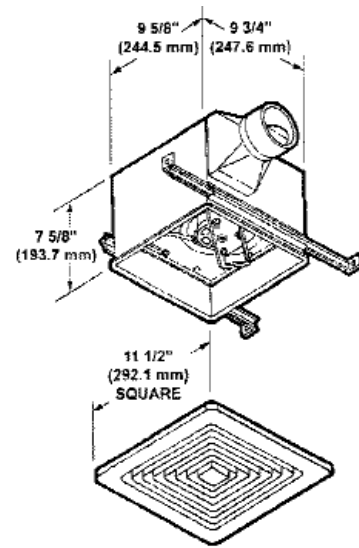

CEILING MOUNT VENTILATORS



Incredibly reliable. Unbelievably quiet. Offering the CFM choices you need at the lowest sound levels in the industry.

L150 SERIES

ACCESSORIES

- Electronic Variable Speed Controls – Model 72V (120 VAC)
- Model 961L In-line Adapter Plate

MODEL NO.	NOMINAL VOLTAGE	CFM / SONES .250" Ps	
L150	120 VAC	CFM Hor.	141
		Sones Hor.	2.2
		CFM Ver.	149
		Sones Ver.	2.0

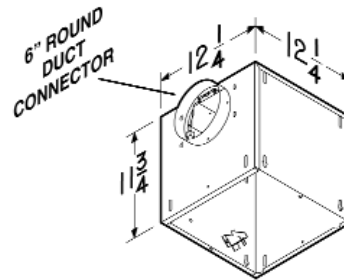

POLYMERIC GRILLE
MODEL L150

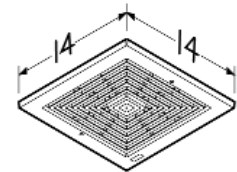

L200 & L300 SERIES

MODEL NO.	NOMINAL VOLTAGE	CFM / SONES .250" Ps		NOMINAL RPM	AMPS @60 Hz
L200	120 VAC	CFM Hor.	196	740	1.8
		Sones Hor.	2.3		
		CFM Ver.	197		
		Sones Ver.	2.3		
L300	120 VAC	CFM Hor.	303	905	2.6
		Sones Hor.	3.3		
		CFM Ver.	306		
		Sones Ver.	3.4		

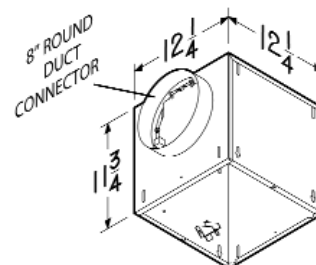

POLYMERIC GRILLE
MODELS L200 & L300

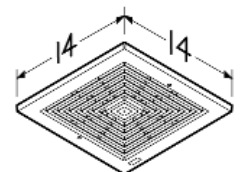

CENTRIFUGAL DIRECT DRIVE EXHAUST FAN MODEL CDD



FEATURES

- Durable and Quiet at Higher Static Pressures
- Suitable for Roof or Wall Mount
- 115V, 1 Phase, 2 Speed, Open Drip Proof Motors
- Bird Screen Standard
- AMCA Licensed for Air
- UL 705 Listed
- Emergency Disconnect Switch Standard
- Non-Overloading, Backward Inclined Wheel
- Variable Speed Control Standard

PERFORMANCE

Catalog Number	SPEED	HP	RPM	TIP SPEED	Capacity (CFM) at "S.P.							
					0"	1/8"	1/4"	3/8"	1/2"	5/8"	3/4"	1"
CDD100-2	High	1/15	1600	3770	541	490	442	394	342	275	197	
CDD120-2	High	1/15	1525	4192	768	690	611	528	439	344	250	
CDD300B-2	High	1/4	1625	4999	1409	1362	1314	1265	1211	1157	1094	955
CDD330B-2	High	1/3	1700	5229	1329	1279	1230	1182	1139	1095	1049	933
CDD550B-2	High	1/2	1650	5940	2564	2488	2410	2333	2244	2155	2066	1833

Speed Control allows for CFM range to 50% of CFM stated.

115V MODELS

Wheel Dia.	EDP Number	Catalog Number	Ship Wt.	2 Sp.	8" Curb 12" Curb	(EDP#) (EDP#)	Gravity Damper Motor Kit	(EDP#) (EDP#)
9"	6310XB15	CDD100-2	30	X	PACA17.75-8 PACA17.75-12	(31100) (31101)	BD14.5A Motor Kit 115/230V	(9021450) (94283)
10-1/2"	6312XB15	CDD120-2	35	X	PACA17.75-8 PACA17.75-12	(31100) (31101)	BD14.5A Motor Kit 115/230V	(9021450) (94283)
10-3/4"	6325CB15	CDD300B-2	45	X	PACA20-8 PACA20-12	(31102) (31103)	BD16.75A Motor Kit 115/230V	(9021670) (94283)
11-3/4"	6330DB15	CDD330B-2	45	X	PACA20-8 PACA20-12	(31102) (31103)	BD16.75A Motor Kit 115/230V	(9021670) (94283)
12"	6350FB15	CDD550B-2	50	X	PACA20-8 PACA20-12	(31102) (31103)	BD16.75A Motor Kit 115/230V	(9021670) (94283)

Motorized damper requires 12" Curb.

DIMENSIONS

Catalog Number	Ht.	W	B	C	Roof Opening
CDD100-2	14"	19"	1-1/2"	19"	12.75"
CDD120-2	16"	21"	1-1/2"	19"	12.75"
CDD300B-2	23-1/2"	27-5/8"	1-1/2"	21"	16"
CDD330B-2	23-1/2"	27-5/8"	1-1/2"	21"	16"
CDD550B-2	23-1/2"	27-5/8"	1-1/2"	21"	16"

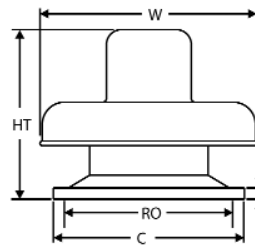

OPTIONAL CURB DIMENSIONS

Curb Cat. No.	A Sq.	B Sq.	Roof Opening	Damper Cat. No.
PACA17.75	17-3/4"	23-3/4"	12-3/4"	BD14.5A
PACA20	20"	24"	15"	BD16.75A

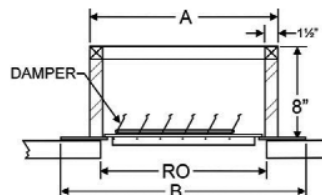

DIRECT DRIVE CENTRIFUGAL UPBLAST/WALL FAN MODEL CDU

Roof and Wall Mount Versatility



FEATURES

- High Vertical Discharge - Prevents Recirculation
- Emergency Disconnect Switch Standard
- Non-Overloading, Backward Inclined Wheel
- Variable Speed Control Standard
- Rubber Vibration Isolators for Quiet Operation
- Compact Size for Easy Installation
- Models CDU120-500 UL 762 Listed for Smoke & Grease Laden Air; Model CDU100 UL 705 Listed

PERFORMANCE

Catalog Number	SPEED	HP	RPM	TIP SPEED	Capacity (CFM) at "S.P.									
					0"	1/8"	1/4"	3/8"	1/2"	5/8"	3/4"	1"	1-1/4"	1-1/2"
CDU100-2	High	1/15	1600	3770	537	493	447	398	343	280	204			
CDU120-2	High	1/15	1500	4123	718	654	584	501	402	304	206			
CDU300B-2	High	1/4	1525	4691	1183	1120	1056	990	916	834	739	541	343	
CDU300B-2	High	1/3	1700	5229	1342	1290	1237	1181	1116	1051	984	831	595	
CDU500B-2	High	1/2	1670	6012	2181	2116	2052	1987	1922	1865	1786	1615	1418	1174

Variable speed control allows for 50% range of stated CFM. Speed control can be wired for low or high speed. Performance shown is for installation Type A; Free Inlet, Free Outlet. Performance includes effect of bird screen in the airstream. Speed (RPM) shown is nominal and performance is based on actual speed of test.

115V MODELS & OPTIONAL CURBS

Wheel Dia.	EDP Number	Catalog Number	Ship Wt.	ODP		Roof Mount	
				2 Speed / 1 Phase 115V	8" Curb 12" Curb (EDP#)	Gravity Damper Motor Kit (EDP#)	(EDP#)
9"	6410XB15	CDU100-2	30	X	PACA17.75-8 (31100) PACA17.75-12 (31101)	BD14.5A (9021450) Motor Kit 115/230V (94283)	
10-1/2"	6412XB15	CDU120-2	40	X	PACA17.75-8 (31100) PACA17.75-12 (31101)	BD14.5A (9021540) Motor Kit 115/230V (94283)	
11-3/4"	6425CB15	CDU250B-2	50	X	PACA20-8 (31102) PACA20-12 (31103)	BD16.75A (9021670) Motor Kit 115/230V (94283)	
11-3/4"	6430DB15	CDU300B-2	50	X	PACA20-8 (31102) PACA20-12 (31103)	BD16.75A (9021670) Motor Kit 115/230V (94283)	
13-3/4"	6450FB15	CDU500B-2	55	X	PACA20-8 (31102) PACA20-12 (31103)	BD16.75A (9021670) Motor Kit 115/230V (94283)	

DIMENSIONS

Wheel Dia.	Catalog Number	Ht.	W	B	C	F	RO
9"	CDU100-2	13-1/3"	19-3/4"	1-1/2"	19"	9-3/4"	12-3/4"
10-1/2"	CDU120-2	15-1/2"	24"	1-1/2"	19"	11-5/8"	12-3/4"
11-3/4"	CDU250B-2	23"	26"	1-1/2"	21"	20-1/2"	16"
11-3/4"	CDU300B-2	23"	26"	1-1/2"	21"	20-1/2"	16"
13-3/4"	CDU500B-2	23"	26"	1-1/2"	21"	20-1/2"	16"

CURB DIMENSIONS

Curb Cat. No.	A Sq.	B Sq.	Roof Opening	Damper Cat. No.
PACA17.75	17-3/4"	23-3/4"	12-3/4"	BD14.5A
PACA20	20"	24"	15"	BD16.75A

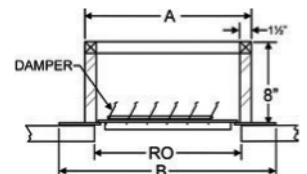
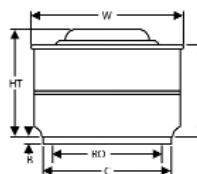

OPTIONAL ACCESSORIES

EDP No.	Catalog Number	Wall Mount Damper (EDP #)	Wall Grille (EDP #)
6410XB15	CDU100-2	D15V (9111500)	WG15 (9121500)
6412XB15	CDU120-2	D15V (9111500)	WG15 (9121500)
6425CB15	CDU250B-2	D17V (9111700)	WG17 (9121700)
6430DB15	CDU300B-2	D17V (9111700)	WG17 (9121700)
6450FB15	CDU500B-2	D17V (9111700)	WG17 (9121700)

ACCESSORIES

EDP No.	Description
62000	Curb Hinge
62001	Bird Screen - for CDU 100 - 120
62002	Bird Screen - for CDU 250 - 500
62003	Grease Box

CENTRIFUGAL BELT DRIVE EXHAUST FAN MODEL CBD*

Handles Higher Static Pressures - Quietly



FEATURES

- Non-Overloading Backward Inclined Wheel
- Aluminum Housing
- Forced Air Thru Motor Compartment
- Variable Pitch Motor Pulley Allows for Field Adjustments
- AMCA Licensed for Sound and Air
- Bird Screen
- Emergency Disconnect Switch Standard
- Suitable for Wall Mount up to CBD240MA
- UL 705 Listed

Wheel Dia.	Use Column at right for last two digits of EDP No.	Cat. Number	HP	Fan RPM	Tip Speed	Max BHP	Capacity (CFM) at "S.P.								
							0"	1/8"	1/4"	3/8"	1/2"	3/4"	1"	1-1/4"	1-1/2"
13"	6513C <input type="checkbox"/>	CBD130CA	1/4	1255	4410	0.29	1985	1892	1799	1705	1609	1357	-	-	-
	6513D <input type="checkbox"/>	CBD130DA	1/3	1328	4780	0.37	2152	2066	1980	1894	1807	1607	1300	-	-
	6513F <input type="checkbox"/>	CBD130FA	1/2	1531	5511	0.57	2481	2406	2332	2258	2182	2031	1850	1598	-
15"	6515D <input type="checkbox"/>	CBD150DA	1/3	1066	4395	0.36	2769	2646	2523	2371	2219	1795	-	-	-
	6515F <input type="checkbox"/>	CBD150FA	1/2	1230	5072	0.56	3195	3088	2982	2867	2735	2452	2069	-	-
	6515H <input type="checkbox"/>	CBD150HA	3/4	1389	5727	0.81	3608	3513	3419	3325	3217	2984	2718	2377	1877
	6515J <input type="checkbox"/>	CBD150JA	1	1527	6296	1.08	3966	3880	3794	3709	3623	3413	3201	2944	2630
18"	6518D <input type="checkbox"/>	CBD180DA	1/3	802	3915	0.36	3114	2952	2789	2600	2391	-	-	-	-
	6518F <input type="checkbox"/>	CBD180FA	1/2	922	4501	0.55	3580	3439	3298	3148	2984	2604	-	-	-
	6518H <input type="checkbox"/>	CBD180HA	3/4	1039	5072	0.79	4035	3909	3784	3659	3520	3227	2866	-	-
	6518J <input type="checkbox"/>	CBD180JA	1	1159	5658	1.10	4501	4388	4276	4164	4051	3793	3513	3189	2763
	6518K <input type="checkbox"/>	CBD180KA	1-1/2	1305	6371	1.57	5068	4968	4868	4768	4669	4457	4225	3976	3688
	6518M <input type="checkbox"/>	CBD180MA	2	1437	7015	2.08	5580	5490	5399	5308	5218	5037	4831	4620	4394
20"	6520D <input type="checkbox"/>	CBD200DA	1/3	671	3624	0.36	3850	3632	3382	3071	2666	-	-	-	-
	6520F <input type="checkbox"/>	CBD200FA	1/2	761	4110	0.49	4366	4174	3981	3725	3435	2541	-	-	-
	6520H <input type="checkbox"/>	CBD200HA	3/4	869	4693	0.79	4986	4817	4649	4460	4234	3691	2751	-	-
	6520J <input type="checkbox"/>	CBD200JA	1	962	5196	1.07	5520	5367	5215	5063	4872	4447	3904	-	-
	6520K <input type="checkbox"/>	CBD200KA	1-1/2	1093	5903	1.57	6271	6137	6003	5869	5735	5385	4993	4523	3830
	6520M <input type="checkbox"/>	CBD200MA	2	1204	6503	2.10	6908	6786	6665	6543	6421	6140	5814	5438	5011
24"	6524H <input type="checkbox"/>	CBD245HA	3/4	658	4264	0.77	6224	5942	5660	5279	4839	3537	-	-	-
	6524J <input type="checkbox"/>	CBD245JA	1	727	4711	1.05	6876	6622	6367	6060	5709	4814	3156	-	-
	6524K <input type="checkbox"/>	CBD245KA	1-1/2	829	5372	1.56	7841	7618	7394	7171	6882	6230	5394	4019	-
	6524M <input type="checkbox"/>	CBD245MA	2	914	5922	2.07	8645	8443	8240	8037	7825	7274	6621	5826	4564
	6524O <input type="checkbox"/>	CBD245OA	3	1050	6804	3.15	9932	9755	9579	9402	9226	8817	8337	7779	7133
30"	6530J <input type="checkbox"/>	CBD300JA	1	504	4074	1.05	8259	7887	7503	7073	6548	5082	-	-	-
	6530K <input type="checkbox"/>	CBD300KA	1-1/2	575	4648	1.56	9423	9097	8770	8421	8032	7039	5647	-	-
	6530M <input type="checkbox"/>	CBD300MA	2	631	5100	2.06	10341	10043	9746	9437	9104	8332	7287	5910	-
	6530O <input type="checkbox"/>	CBD300OA	3	727	5876	3.16	11914	11656	11398	11140	10868	10277	9584	8702	7619
	6530P <input type="checkbox"/>	CBD300PA	5	859	6943	5.20	14077	13859	13641	13422	13204	12744	12241	11720	11022
36"	6536J <input type="checkbox"/>	CBD365JA	1	377	3677	1.01	10900	10230	9487	8630	7285	-	-	-	-
	6536K <input type="checkbox"/>	CBD365KA	1-1/2	430	4193	1.56	12433	11845	11244	10542	9749	-	-	-	-
	6536M <input type="checkbox"/>	CBD365MA	2	475	4632	2.07	13734	13202	12670	12065	11429	9688	-	-	-
	6536O <input type="checkbox"/>	CBD365OA	3	544	5305	3.09	15729	15265	14800	14366	13781	12641	10930	-	-
	6536P <input type="checkbox"/>	CBD365PA	5	643	6271	5.19	18592	18199	17806	17413	17020	16096	15157	13894	11990

Performance shown is for installation Type A: Free Inlet; Free Outlet. Power Ratings (BHP) do not include Drive Losses. Performance ratings do not include the effects of appurtenances in the air stream.

DIMENSIONS

Catalog Number	Ht.	W	B	C	RO
CBD130	25-1/2"	28-1/4"	1-1/2"	21"	15"
CBD150	28-1/4"	31-1/2"	2"	24-3/4"	18.75"
CBD180	31-1/2"	37-1/2"	2"	28"	22"
CBD200	31-1/2"	37-1/2"	2"	28"	22"
CBD245	37-1/2"	42"	1-1/2"	33"	27"
CBD300	39"	51-1/4"	2"	40"	34"
CBD365	42-1/2"	61-3/8"	2"	44"	38"

* Non-Stock item.

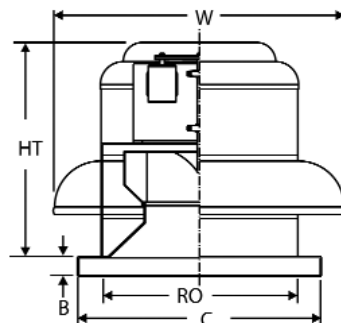

CENTRIFUGAL BELT DRIVE EXHAUST FAN MODEL CBD

Cat. Number	Max. Sones	Ship Wt.	Ends		8" Curb 12" Curb	(EDP#) (EDP#)	Damper - Gravity Motorized Damper Kit	(EDP#) (EDP#)
			in 09	in 12				
CBD130CA	10.8	105	X	-	PACA20-8	(31102)	BD16.75A	(9021670)
CBD130DA	11.8	105	X	X	PACA20-12	(31103)	Motor Kit 115/230V	(94283)
CBD130FA	17.1	105	X	X			Motor Kit 460V	(94282)
CBD150DA	10.2	120	X	X	PACA23.75-8	(31107)	BD29A	(9022900)
CBD150FA	13.0	120	X	X	PACA23.75-12	(31108)	Motor Kit 115/230V	(94283)
CBD150HA	15.8	130	X	X			Motor Kit 460V	(94282)
CBD150JA	21.0	130	X	X				
CBD180DA	8.3	150	X	X	PACA27-8	(31112)	BD23.75A	(9022370)
CBD180FA	10.2	150	X	X	PACA27-12	(31113)	Motor Kit 115/230V	(94283)
CBD180HA	12.5	160	X	X			Motor Kit 460V	(94282)
CBD180JA	13.9	160	X	X				
CBD180KA	19.2	180	X	X				
CBD180MA	24.0	190	X	X				
CBD200DA	7.0	155	X	X	PACA27-8	(31112)	BD23.75A	(9022370)
CBD200FA	8.4	155	X	X	PACA27-12	(31113)	Motor Kit 115/230V	(94283)
CBD200HA	10.0	165	X	X			Motor Kit 460V	(94282)
CBD200JA	12.8	165	X	X				
CBD200KA	15.0	185	X	X				
CBD200MA	19.8	195	-	X				
CBD245HA	11.0	185	X	X	PACA32-8	(31115)	BD37A	(9023700)
CBD245JA	13.0	185	X	X	PACA32-12	(31116)	Motor Kit 115/230V	(94283)
CBD245KA	14.8	205	X	X			Motor Kit 460V	(94282)
CBD245MA	17.7	215	-	X				
CBD245OA	25.0	215	-	X				
CBD300JA	8.3	315	X	X	PACA39-8	(31118)	BD44A	(9024400)
CBD300KA	10.7	335	X	X	PACA39-12	(31119)	Motor Kit 115/230V	(94283)
CBD300MA	12.6	345	-	X			Motor Kit 460V	(94282)
CBD300OA	14.8	345	-	X				
CBD300PA	21.0	380	-	X				
CBD365JA	7.4	335	X	X	PACA43-8	(31121)	BD39.75A	(9023970)
CBD365KA	10.2	355	X	X	PACA43-12	(31122)	Motor Kit 115/230V	(94283)
CBD365MA	11.5	365	-	X			Motor Kit 460V	(94282)
CBD365OA	14.9	365	-	X				
CBD365PA	19.7	400	-	X				

The sound ratings shown are loudness values in fan sones at 5 ft. (1.5m) in a hemispherical free field calculated per AMCA Standard 301. Values shown are for installation Type A: Free inlet fan sone levels. Sones are given for the highest value over catalog range.

OPTIONAL CURB DIMENSIONS

Curb Cat. No.	A Sq.	B Sq.	Roof Opening	Damper Cat. No.
PACA20	20"	24"	15"	BD16.75A
PACA23.75	23.75"	27.75"	18.75"	BD29A
PACA27	27"	31"	22"	BD23.75A
PACA32	32"	36"	27"	BD37A
PACA39	39"	43"	34"	BD44A
PACA43	43"	47"	38"	BD39.75A

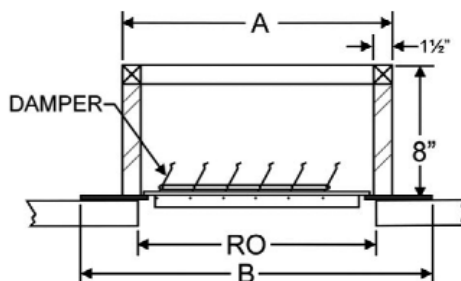

ACCESSORIES

EDP No.	Description
62000	Curb Hinge

BELT DRIVE CENTRIFUGAL UPBLAST EXHAUST FAN MODEL CBU*

High Efficiency...Quiet Operation



FEATURES

- Non-Overloading Backward Inclined Aluminum Wheel
- Suitable for Wall Mount up to CBU245
- Variable Pitch Motor Pulley Allows for Field Adjustment
- Emergency Disconnect Switch Standard
- AMCA Licensed for Sound and Air
- UL 762 Listed for Smoke & Grease Laden Air

Wheel Dia.	Use Column at right for last two digits of EDP No.	Cat. Number	HP	Fan RPM	Tip Speed	Max BHP	Capacity (CFM) at "S.P.								Sones@ .25"S.P.
							1/4"	3/8"	1/2"	3/4"	1"	1-1/4"	1-1/2"	2"	
13"	6613C <input type="checkbox"/>	CBU130CA	1/4	1216	4377	0.28	1746	1652	1556	1294	-	-	-	-	13.8
	6613D <input type="checkbox"/>	CBU130DA	1/3	1331	4791	0.37	1940	1861	1773	1580	1267	-	-	-	16.6
	6613F <input type="checkbox"/>	CBU130FA	1/2	1535	5526	0.57	2278	2216	2145	1993	1820	1564	-	-	22
15"	6615D <input type="checkbox"/>	CBU150DA	1/3	1069	4408	0.36	2445	2303	2154	1758	-	-	-	-	13.1
	6615F <input type="checkbox"/>	CBU150FA	1/2	1225	5051	0.55	2866	2756	2632	2349	1989	-	-	-	15.3
	6615H <input type="checkbox"/>	CBU150HA	3/4	1395	5752	0.81	3317	3228	3126	2908	2644	2334	1818	-	18
	6615J <input type="checkbox"/>	CBU150JA	1	1529	6305	1.07	3669	3587	3506	3308	3104	2848	2560	-	23
18"	6618D <input type="checkbox"/>	CBU180DA	1/3	805	3930	0.36	2739	2556	2361	1851	-	-	-	-	9
	6618F <input type="checkbox"/>	CBU180FA	1/2	913	4457	0.53	3196	3037	2876	2527	-	-	-	-	11.7
	6618H <input type="checkbox"/>	CBU180HA	3/4	1044	5097	0.79	3733	3603	3462	3174	2866	2421	-	-	15.3
	6618J <input type="checkbox"/>	CBU180JA	1	1157	5649	1.08	4190	4075	3953	3699	3430	3151	2743	-	18.7
	6618K <input type="checkbox"/>	CBU180KA	1-1/2	1319	6439	1.59	4837	4736	4635	4417	4194	3959	3714	3052	23
20"	6620D <input type="checkbox"/>	CBU200DA	1/3	673	3635	0.36	3292	2992	2598	-	-	-	-	-	8.9
	6620F <input type="checkbox"/>	CBU200FA	1/2	766	4173	0.53	3884	3643	3367	2599	-	-	-	-	12
	6620H <input type="checkbox"/>	CBU200HA	3/4	875	4726	0.79	4527	4364	4143	3615	2889	-	-	-	14.2
	6620J <input type="checkbox"/>	CBU200JA	1	968	5228	1.07	5067	4934	4762	4359	3821	3068	-	-	16.5
	6620K <input type="checkbox"/>	CBU200KA	1-1/2	1100	5941	1.57	5826	5709	5593	5264	4894	4423	3871	-	21
24"	6624H <input type="checkbox"/>	CBU245HA	3/4	659	4270	0.78	5445	5091	4716	3646	-	-	-	-	12.5
	6624J <input type="checkbox"/>	CBU245JA	1	730	4730	1.06	6157	5857	5537	4782	-	-	-	-	15.4
	6624K <input type="checkbox"/>	CBU245KA	1-1/2	831	5384	1.56	7147	6915	6636	6063	5357	4193	-	-	18.7
	6624M <input type="checkbox"/>	CBU245MA	2	912	5909	2.07	7930	7718	7492	6980	6427	5743	4648	-	21
	6624O <input type="checkbox"/>	CBU245OA	3	1050	6804	3.15	9246	9066	8882	8471	8026	7554	6997	5267	27
	6624P <input type="checkbox"/>	CBU245PA	5	1241	8041	5.21	11054	10900	10774	10434	10083	9707	9331	8456	37
30"	6630H <input type="checkbox"/>	CBU300HA	3/4	458	3702	0.77	6445	5941	5388	-	-	-	-	-	9
	6630J <input type="checkbox"/>	CBU300JA	1	507	4098	1.05	7305	6895	6419	5333	-	-	-	-	11.4
	6630K <input type="checkbox"/>	CBU300KA	1-1/2	577	4664	1.55	8494	8184	7801	6949	5945	-	-	-	14.3
	6630M <input type="checkbox"/>	CBU300MA	2	635	5133	2.06	9453	9189	8884	8147	7335	6377	-	-	16.6
	6630O <input type="checkbox"/>	CBU300OA	3	731	5909	3.15	11016	10806	10573	10017	9362	8669	7887	-	21
	6630P <input type="checkbox"/>	CBU300PA	5	864	6984	5.19	13153	12985	12409	11942	11400	10829	9582	-	27
36"	6636K <input type="checkbox"/>	CBU365KA	1-1/2	429	4184	1.55	11593	10935	10138	-	-	-	-	-	12
	6636M <input type="checkbox"/>	CBU365MA	2	470	4583	2.05	12917	12349	11716	9975	-	-	-	-	14.6
	6636O <input type="checkbox"/>	CBU365OA	3	542	5286	3.14	15195	14737	14236	13080	11483	-	-	-	18.3
	6636P <input type="checkbox"/>	CBU365PA	5	640	6241	5.19	18234	17864	17474	16625	15644	14424	12824	-	25

DIMENSIONS

Wheel Dia.	Catalog Number	Ht.	W	B	C	F	RO
13"	CBU130	25-1/2"	28-1/4"	1-1/2"	21"	23"	15"
15"	CBU150	28-1/4"	31-1/2"	2"	24-3/4"	23"	18.75"
18"	CBU180	31-1/2"	37-1/2"	2"	28"	26"	22"
20"	CBU200	31-1/2"	37-1/2"	2"	28"	26"	22"
24"	CBU240	37-1/2"	42"	1-1/2"	33"	31"	27"
30"	CBU300	39"	51-1/4"	2"	40"	33-1/8"	34"
36"	CBU360	42-1/2"	61-3/8"	2"	44"	45-1/4"	38"

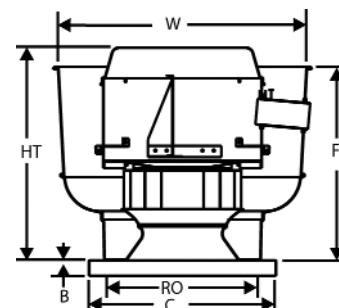

NOTE: Instructions for Wall Mounting included with each fan.

* Non-Stock item.

BELT DRIVE CENTRIFUGAL UPBLAST EXHAUST FAN MODEL CBU

Cat. Number	Ship Wt.	Ends in 09	Ends in 12	Optional Accessories				
		1 Phase	3 Phase	8" Curb (EDP#)		Damper/Gravity (EDP#)		Wall Mount
		Single Speed (ODP)		12" Curb (EDP#)		Motorized Damper Kit (EDP#)		Damper (EDP#)
		115/230V	208/230/460V	18" High		Motorized Damper Kit (EDP#)		Wall Grille (EDP #)
				Ventilated Curb (EDP #)				
CBU130CA	120	X	-	PACA20-8	(31102)	BD16.75A	(9021670)	D17V (9111700)
CBU130DA	120	X	X	PACA20-12	(31103)	Motor Kit 115/230V	(94283)	WG17 (9121700)
CBU130FA	120	X	X	PACA20-18V	(31104)	Motor Kit 460V	(94282)	
CBU150DA	130	X	X	PACA23.75-8	(31107)	BD29A	(9022900)	
CBU150FA	130	X	X	PACA23.75-12	(31108)	Motor Kit 115/230V	(94283)	D17V (9111700)
CBU150HA	140	X	X	PACA23.75-18V	(31109)	Motor Kit 460V	(94282)	WG17 (9121700)
CBU150JA	140	X	X					
CBU180DA	150	X	X					
CBU180FA	150	X	X	PACA27-8	(31112)	BD23.75A	(9022370)	D17V (9111700)
CBU180HA	160	X	X	PACA27-12	(31113)	Motor Kit 115/230V	(94283)	WG17 (9121700)
CBU180JA	160	X	X	PACA27-18V	(31114)	Motor Kit 460V	(94282)	
CBU180KA	180	X	X					
CBU200DA	155	X	X					
CBU200FA	155	X	X	PACA27-8	(31112)	BD23.75A	(9022370)	D17V (9111700)
CBU200HA	165	X	X	PACA27-12	(31113)	Motor Kit 115/230V	(94283)	WG17 (9121700)
CBU200JA	165	X	X	PACA27-18V	(31114)	Motor Kit 460V	(94282)	
CBU200KA	185	X	X					
CBU245HA	200	X	X					
CBU245JA	200	X	X	PACA32-8	(31115)	BD37A	(9023700)	D20V (9112000)
CBU245KA	220	X	X	PACA32-12	(31116)	Motor Kit 115/230V	(94283)	WG20 (9122000)
CBU245MA	230	-	X	PACA32-18V	(31117)	Motor Kit 460V	(94282)	
CBU245OA	230	-	X					
CBU245PA	270	-	X					
CBU300HA	340	X	X					
CBU300JA	340	X	X	PACA39-8	(31118)	BD44A	(9024400)	
CBU300KA	360	X	X	PACA39-12	(31119)	Motor Kit 115/230V	(94283)	N/A
CBU300MA	370	-	X	PACA39-18V	(31120)	Motor Kit 460V	(94282)	
CBU300OA	370	-	X					
CBU300PA	410	-	X					
CBU365KA	500	X	X	PACA43-8	(31121)	BD39.75A	(9023970)	
CBU365MA	510	-	X	PACA43-12	(31122)	Motor Kit 115/230V	(94283)	N/A
CBU365OA	510	-	X	PACA43-18V	(31123)	Motor Kit 460V	(94282)	
CBU365PA	550	-	X					

Backdraft Damper not for use in kitchen exhaust applications.

CURB DIMENSIONS

Curb Cat. No.	A Sq.	B Sq.	Roof Opening	Damper Cat. No.
PACA20	20"	24"	15"	BD16.75A
PACA23.75	23.75"	27.75"	18.75"	BD29A
PACA27	27"	31"	22"	BD23.75A
PACA32	32"	36"	27"	BD37A
PACA39	39"	43"	34"	BD44A
PACA43	43"	47"	38"	BD39.75A

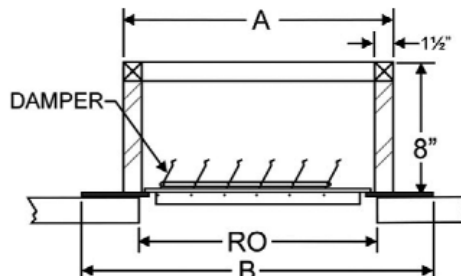

ACCESSORIES

EDP No.	Description
62000	Curb Hinge
62002	Bird Screen
62003	Grease Box